



Gen II

Custom MUD Tiled Shower Kit

Installation Instructions
Applies to any sized MUD waterproofing kit

Please read all instructions thoroughly before beginning. If you have questions, please call.

VERY IMPORTANT!

READ THE FOLLOWING BEFORE STARTING INSTALLATION

DO NOT use any brand or version of PRE-MIXED thin-set mortar with this kit installation or tiling after kit installation.

DO NOT use any thin-set mortar modified or non-modified that comes pre-made in a bucket or pail. None of these thin-set mortars will reliably cure with any brand of waterproof membranes. **DO NOT** use mastics or other ready-to-use-in-a-bucket type tile adhesives.

DO USE polymer/modified thin-set mortars that are sold as a dry powder in a bag (typically 50#) and have to be thoroughly mixed with water to activate and apply.

DO USE a well-known name brand polymer/modified thin-set mortar to include companies like but not limited to (HB Fuller) TEC, Laticrete, Mapei, Ardex, (CBP) Custom Building Products available from your local hardware store.



Gen II

Custom MUD Tiled Shower Kit

Installation Instructions

Applies to any sized MUD waterproofing kit

Please read all instructions thoroughly before beginning. If you have questions, please call.

Tools & Materials Required or Recommended

- Jigsaw (for subfloor drain hole) & Drill (for pilot hole)
- Premium Modified (Latex/Polymer) Thin-set Mortar (no premixed)
- Dry-pack mortar mix (consisting of 1 part Portland cement, 4 parts clean sand)
- Lathe with backing or lathe and 15 lb felt paper (for wood subfloors only)
- 15 lb felt paper to protect wood curb core (if building concrete curb)
- Concrete board, gypsum or other hard board for walls, drywall screws, etc.
- 5-Gallon Bucket
- Wheel barrel, box or large bucket for mixing dry-pack mortar
- Mixer
- Shovel (for dry-pack mortar)
- 1/4" x 3/8", 3/16" x 3/16" up to 1/4" x 1/4" square or V-notch trowel
- Margin Trowel (optional) - may use flat edge of standard trowel
- Utility Knife
- PVC or ABS Cement, and section of coupler pipe for connection
- Level
- 2x4 or other straight-edge component for screeding
- Industrial double-stick tape (for concrete subfloors)

Included in kit

- 6 or More Float Sticks appropriate for size of kit
- Extension Float Sticks if appropriate for size of kit
- 108 - 323 SF Pro WP waterproofing membrane (based on size)
- 33 - 98 LF Pro WP waterproof joint band (based on size)
- 4 Pro WP pre-shaped inside corners
- GEN II flange with ABS/PVC neck
- Drain Grate riser with construction plug
- Hair Trap & Choice of Drain Grate cover
- 1 Pro WP Universal Pipe Seal
- 1 Pro WP Mixing Valve Seal
- Quick Clips for some kits
- Curb pieces if optionally ordered
- 2 outside corners with curb purchase

1. Ensure that your subfloor is flat, clean and level to within 1/8" variance. If not, use leveling compound before beginning installation. You will need to check several locations in the floor area. Starting with an out-of-level subfloor could later create hills and valleys that don't drain properly.
2. Locate drain position and test fit for preparation of installation of your drain flange onto the 2" waste outlet pipe. Some older buildings may have 1-1/2" waste pipe that will need to be converted to 2" ABS or PVC depending upon code requirements for your area. Your code may require that you have a plumber physically complete any of this work to include gluing the flange onto the drain pipe. Please check all local codes to ensure legal compliance.
3. Set up your plumbing drainage pipe height so that your GEN II flange properly interfaces with the wide 6" base of the flange squarely supported by the sub-floor. To accomplish this, the top of your drain pipe should be about 1-1/2" below the top of the flat subfloor where the drain flange sits. Be sure to dry fit drain to pipe to ensure proper fit.
4. When working with a wood sub-floor, also ensure that it's design is structurally sound to meet building codes and to properly support the concrete that you will be using over it. Before continuing installation on a wood floor, you should install a paper or barrier-backed lathe onto the sub-floor to protect the wood from undue moisture and to add some strength. If only plain lathe is available, first staple down 15 lb. felt or tar paper then screw down the metal lathe. The top of the lathe should now be considered your sub-floor height.

5. Glue your GEN II flange in place with ABS/PVC cement.

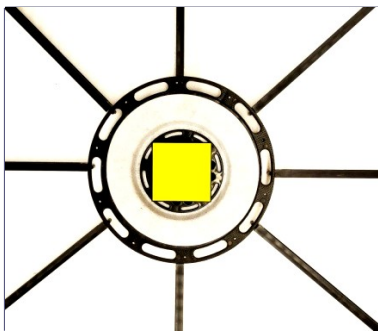
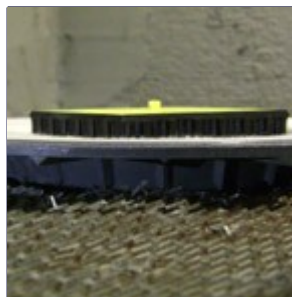
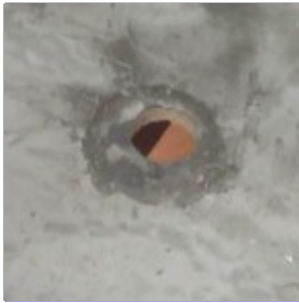

TOP VIEW

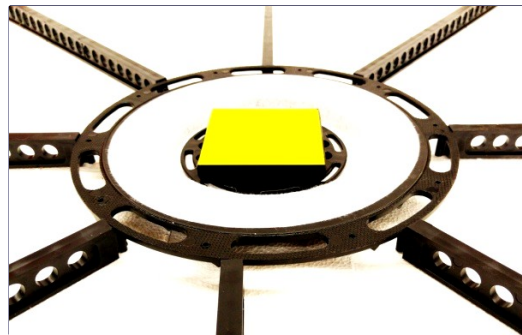

SIDE VIEW



STICK NOTCH CLOSE-UP

6. If you are working with a slab floor, a 2" drain pipe with sufficient or excess length should be in place. This exact configuration will vary depending upon the builder's preferences and other requirements. The drain flange will need to be test fitted and the drain pipe appropriately cut in order for the base of the flange to set with the base of the flange on level with the subfloor once glued into position. A slightly wet mixture of dry-pack mortar (4 parts sand, 1 part Portland-cement) can be used to form additional support for the drain flange if needed. You will not require lathe or felt for a slab floor.

7. You have many choices of wall boards suitable to cover your walls including drywall. We prefer concrete board because of its additional strength compared to drywall, but its use is not a requirement. Please avoid any pre-waterproofed substrates and do not apply any type of topical or liquid waterproofing over the board. The Pro WP membrane included in this kit provides a complete waterproof barrier. Additional waterproofing barriers behind the Pro WP can dramatically slow cure times of your thin-set mortar.

1. SUBFLOOR & PREP

2. SLOPE STICKS AND DRYPACK MORTAR

3. GEN II FLANGE

-RISER HAIRTRAP AND RING

***SHOWN WITH CONSTRUCTION COVER**

4. THINSET & TILE

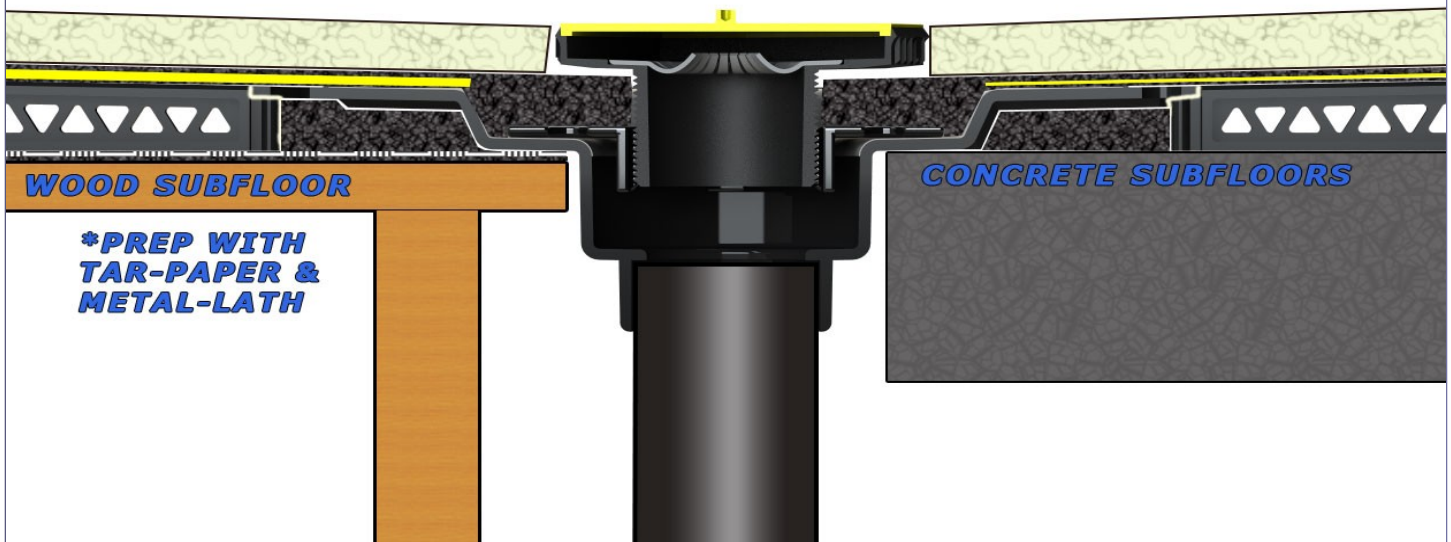

8. If you are planning for shampoo/soap niches, ensure your studs are set as necessary to accommodate for desired niche location(s). We recommend pre-waterproofed ready-to-install niches (see web site) over building out a niche due to the additional waterproofing complexities involved with a built space. Complete installation of all walls and curbing (read next section) before starting floor or waterproofing installation. Use shims to bring walls up 1/4" from the subfloor. It is helpful to apply self-adhesive fiberglass drywall tape or equivalent over all seams to help make membrane installation even easier.
9. If you will be using the optional standard curb form, install stacked 2x4's to establish your curb threshold. To protect your wood curb from moisture damage from the cement, cover with 15 lb. felt paper or other appropriate vapor barrier. A staple gun may be used to hold down the barrier. Additionally, if you did not order a concrete curb form, you will not require vapor barrier over the 2x4's. Instead, attach a board substrate (concrete board, drywall, etc.) over the 2x4 curb section. Do not apply Pro WP over bare wood.



10. If you are installing the standard cement curb form(s), install now. These sections are 30" long and come in three pieces. Assemble the top and two sides of each section and place over the protected 2x4's. Use a hand or power saw to custom cut any section that needs to be less than 30" to custom fit your curbing installation. Use 1-1/2" galvanized nails to nail the outside section of the curb form onto the 2x4's.
11. If installing a handicap curb form, interlock the multiple pieces together (if more than a single 30" section) and use a hand or power saw to cut the end of one section to fit the curb threshold area. Test fit the position of your curb but do not attach to the floor yet. You will need to leave the form in position to help determine the pitch stick layout.



12. Layout the sticks included in your kit starting with the small or notched end at the wall or curb and crossing over the drain flange area to get a good idea of length for each stick. For areas longer than 36" from the drain flange, you will need to lock in an extension stick that will give you up to another 36". You will want to arrange the sloped float sticks so that there is a stick in each corner crossing to the drain area. Additionally, you will want to position a stick so that the distance between each adjacent stick is no more than 30". Having sticks closer than 30" will allow for easier screeding.



13. Reverse mark the largest end of each stick or float + extension assembly where it contacts or crosses the edge of the drain flange. You may then cut with a PVC pipe cutter, hacksaw or other appropriate tool at your indicated mark. It is better to be a little loose than too tight. Reverse the stick assembly direction so that small or notched end rests against the drain flange and the other end touches the wall or curb. It is preferable but not critical that the notch on at the drain flange faces down. Fasten each stick assembly to concrete floors using double-sided stick tape. For wood subfloors, use the included quick clips to fasten each stick assembly down with a screwdriver.



14. With flange and riser dry fit in place, Mix the dry ingredients of your mud (1 part Portland cement and 4 parts clean sand) with your shovel or trowel. Add enough water to the dry admix (or premix) to bring this floor floating material to the consistency of a compact snowball (see figure). This consistency will allow the material to be easily distributed, troweled and tamped. Shovel this mix into the pan area - bury the float sticks slightly.

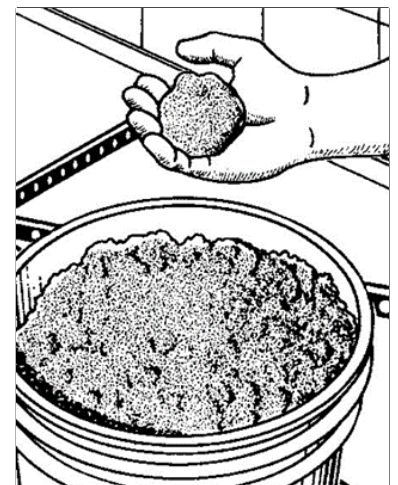

15. Starting at the back furthest from the entrance to the shower, spread and pack the mix fully between and around the sticks with a flat trowel. Using a straight edge, 2x4 or other suitable tool that is large enough to span the stick gaps, screed the packed mix to the top surface of the sticks. Be careful not to allow any dips, valleys or high points between sticks. Be sure to pack in mud in and around where the float sticks make contact with the drain flange and the sloped edge of the drain flange. Continue screeding until area is smooth and properly sloped with no hills or valleys. Also pack mortar under the flange then temporarily pull out the drain flange to fill any gaps or holes. Then, reseal the flange to ensure that it still fits correctly into place. *It doesn't have to be perfect - you will complete bedding of flange with modified thin-set mortar.* Pull the flange out and set aside for later.



16. Replace the curb form (if used) and attach in place with tapcon screws. Then use trowel to pack the form with mortar.

-For the standard curb form, make your mud mixture a bit wetter and pack the form around the encased and protected 2x4's with this mixture. Then screed the curb smooth. Let the entire mud job dry for 24 to 48 hours.

-For the handicap curb form install, remove the handicap form from its test-fit position and shovel a row of mud along the length of the handicap curb run. Press handicap curb form into mud and into its proper position. Screw down the handicap curb form into position with 1-1/4" screws (Tapcon screws for concrete) subfloors. Fill and pack any remaining voids in the form with additional mud and screed smooth with a trowel. (see next page for images)



17. After the floor is dry (24–48 hours. Dry time varies based on temperature humidity and ventilation). Apply a thin layer of modified thin-set mortar into your drain "pocket", set up your ABS or PVC cement for bonding the flange to the drain pipe, then seat the flange into place while simultaneously gluing the pipe into the flange waste connector. Scrape away excess thin-set mortar forced out by the seating of the GEN II flange. *plug drain to prevent thin-set from going down the drain during waterproofing installation.
18. These instructions show the installation from the floor up. We highly recommended to allow the floor installation to cure 24 hours before proceeding with the wall and other installation steps. If you need to complete this installation more quickly - to avoid risk of disturbing the floor installation, we recommend reversing the installation order (walls first starting at the bottom and going up) then finish with the floor install. Please be sure to set aside the correct quantity of membrane for your floor section if using this method.

19. Your waterproofing membrane is 1 meter or 39.5" wide. The integrity of your entire shower kit installation will rely on overlapping membranes at least two inches from section to section or piece to piece. On shower kits up to 39.5" wide you can precut a single sheet of membrane and precut enough relief for the drain hole if desired. On all other shower kit configurations or on larger mortar bed layouts, you will need to plan for at least two sheets with a minimum of a 2" overlap. Ensure that the two pieces DO NOT overlap at the center of the drain location to help ensure installation integrity. In all cases install only one width at a time, working from the back to the front.



20. A single piece of membrane can be used for 39.5" wide or narrower installations, trowel premium modified thin-set over the area to be covered including the top of the drain-flange fleece with a 1/4" x 3/16" v-notch up to a 1/4" x 1/4" square trowel. Lay membrane starting from the back of the shower working out excess toward yourself with your hands as you go. Peel back a portion you have just lain to ensure complete coverage.
21. Use the flat side of your trowel or a margin trowel to press the membrane into the thin-set on the subfloor and the drain flange flashing. During installation, run hands over membrane to ensure that no air bubbles are trapped. Test installation by peeling back membrane to ensure 100% coverage. Keep working in membrane or adding additional thin-set if necessary to ensure 100% thin-set coverage.
22. **For pan areas larger than 39.5 on the shortest side**, trowel premium modified thin-set mortar onto one side of the pan area with a 3/16" x 3/16" or 1/4" x 3/16" V-notch trowel up to a 1/4" x 1/4" square trowel. You may use the "traditional" 1/8" x 1/8" square trowel but will be adding extra work to ensure 100% thin-set coverage of membrane. Lay one of your sections into the mortar and press vigorously into the thin-set with the flat section of your trowel. Peel back membrane as a test to ensure you have achieved 100% coverage. Keep working and/or add thin-set to achieve 100% coverage. During process, run hands over membrane to ensure no air bubbles form. Work out any excess thin-set with the flat edge of your trowel if necessary.

Trowel at least 2" wide path of thin-set to prepare for the membrane overlap. Repeat previous process of laying overlapping membrane into thin-set and pressing in with flat end of trowel. Many times throughout the entire kit installation, peel back the membrane to ensure you are achieving 100% thin-set coverage of the membrane. Finalize the overlap installation in this section of the pan floor by pressing and smoothing the overlapping membrane section at the seam.

Repeat the installation process on any remaining sections of the pan area until the entire all sections of membrane are completely overlapped at least 2" in every direction and properly seated into the thin-set.

23. Cut out circle from flange area using utility knife using flange "depression as a guide". Using the flat side of a trowel press out excess into "depression". Work your way all the way around the flange in this way to ensure complete coverage and a strong bond of WP to the flange.
24. Trowel thin-set into an inside corner to prepare for the pre-shaped inside corner piece. Fit the corner piece into position by hand. Using a margin trowel or the flat section of your trowel, press the corner into the thin-set area to ensure a complete bond. Be sure to peel a section back to check for 100% coverage. Smooth the corner out and check for air bubbles. A properly installed corner blends into the installation as shown in the picture. Repeat for all 4 inside corners.

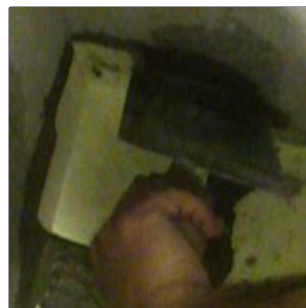

25. If you have a curb; and if you received or purchased pre-shaped outside corners, install them where the top section of the curb meets the adjoining wall. Use the same technique as used with the inside corners to install outside corners. If your kit did not include a pre-shaped outside corner (e.g. you didn't order a curb with the kit) or if you need additional corners you do not have on hand, you may create one by cutting out a rectangular piece of Pro WP then cutting a slit half way down the middle lengthwise with a razor knife. Then crease the piece down the same line as the partial cut. The crease will "ride" the inside ridge of the top of the curb with each "leg" of the corner contacting the wall.
26. Measure your joint seam band section and cut your 5" or 6" wide band to measurement. The following photos show a very short section for more practical viewing. Fold strip in half lengthwise and press to crease. Test fit pre-creased section to ensure proper fit. Trowel thin-set onto the section to prepare for the pre-creased joint band section. Fit the joint band piece into position by hand. Using a margin trowel or the flat section of your trowel, press the section into the thin-set area to ensure a complete bond. Be sure to peel a section back to check for 100% coverage. Smooth out

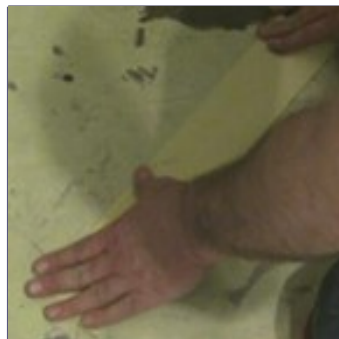
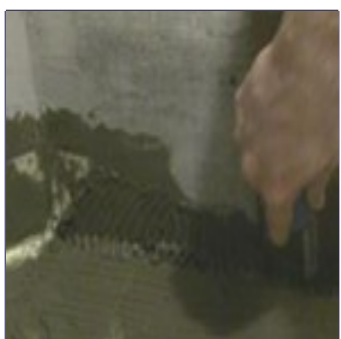

and check for air bubbles.

27. You may wish to wait for the floor to cure a bit before proceeding (please read previous comments regarding alternative install order to avoid risk of disturbing floor). In any case, take care when moving over your freshly-installed floor sections. After completing all lower horizontal joint strips, proceed to installing vertical joint strips using the exact same techniques. If you are not taking your tiling all the way up to the ceiling, be sure to mark where your tiling will end and measure the correct

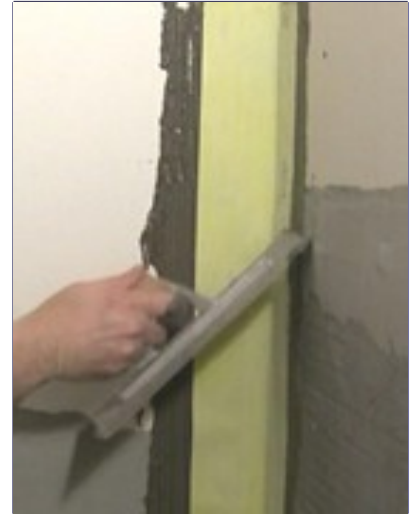
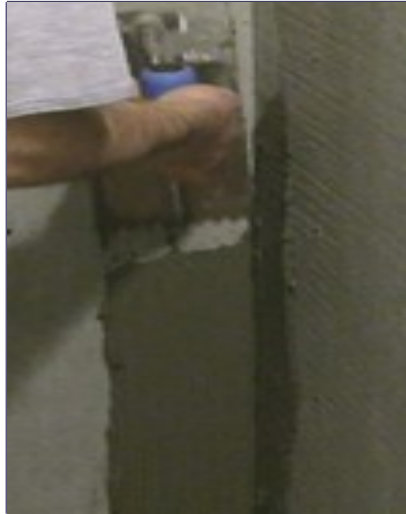

length for each piece. Repeat for any vertical corner surfaces. Note: If you run short on band, you can create your own out of any excess membrane.

28. With all joints and corners complete, begin to install the wall pieces starting from the bottom up.

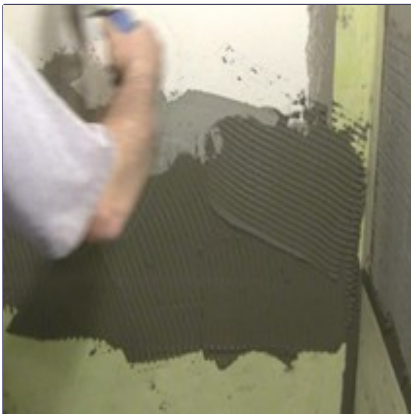

Ensure at least a 2" overlap on any adjoining sections. Installation continues exactly like it did for floor sections. As always, peel back membrane to ensure 100% coverage and constantly run hands over membrane to feel for any trapped air bubbles.

29. Allow installation to dry / cure. Although modified thin-set provides a superior installation, it does take longer to cure than unmodified thin-set. A box fan in the room circulating air will help speed cure time. You probably will need at least 24 hours for a reasonable cure. You may test an exposed bit of thin-set with the point of your razor knife to test cure progress. After installation has completely cured, most codes require proper flood testing. Please check for your local requirements.
30. With a shower floor tile ready, thread in your drain riser with construction plug into supplied threaded ring and remove the stopper being used to protect the drain waste pipe from debris.
31. Insert riser and ring assembly into flange depression and secure with a dry mix of modified thin-set mortar or dry pack mortar while using a tile to align and level to the construction cover.

This might be a good time to swap your construction plug for the actual grate to ensure you have the riser height you need. To remove construction plug (black cover) at any time, drive a dry-wall screw a few turns into the center indent of the cover, grab the screw (with pliers if necessary), and pull.

*Remember, the tile does not yet have thin-set on it. You must allow for the thickness of the thin-set



used to set the tile when adjusting height and level of the riser. A layer of material equaling half of the depth of notched trowel can be used to stand in for the thin-set in this step.



*If desired the use pea-gravel to partially fill around the riser to increase effectiveness of weep holes is acceptable. Do not over fill, fill only to level with the sloped pan surface, this can be checked with a tile.

32. Use spacers to dry fit your floor tile within a grout-space width of the riser-construction plug. Our example photo shows an installation involving complex cuts.
33. Finish Setting the remainder of your tile around the riser. After the thin-set mortar has completely cured, your installation is ready for grout.

Additional Considerations

- **Choosing the highest quality premium modified (latex/polymer) thin-set you can find will make your installation much easier and yield better results. After decades of using every brand available, we highly recommend TEC brand adhesives which are available on our web site(s). However, we certainly understand the high cost of shipping heavy materials. If purchasing locally - as of 1/1/2013, your local retail price for a high-quality 50# bag of thin-set generally ranges from \$25 to \$35. Please question the quality of anything costing less unless you have special purchasing power.**
- **Despite claims to the contrary regarding waterproof membranes, modified thin-set is recommended by the Tile Council of America (TCA) for most modern tile installations and provides contemporary standards of performance. Fortunately, your Pro WP is fully tested and backed for use with these superior thin-set mortars. Maximizing air flow in the work area will really help accelerate cure times of your thin-set.**
- **If you are installing very large, heavy tiles on your walls (12 x 18s, 12 x 24s), we highly recommend purchasing our TEC Ultimate Performance large-format Latex Modified Mortar - the 40 lb bag yields the same coverage as a 50 lb bag of standard-style mortar. This mortar is rated for thin-set or medium-set beds. No other mortar compares to the non-slump holding power of this product.**
- **Rather than sealing and resealing and scrubbing grout, we recommend the use of TEC's Power Grout. This grout has been engineered to perform like very expensive epoxies and urethane grouts but offer lower pricing and much easier installation. Power Grout is VERY stain resistant, permanently sealed, won't effloresce or discolor, is easy to install like standard grout, and cures very quickly - 4 hours for dry traffic, 24 hours for wet.**
- **If your installation requires a grout color not available in the Power Grout family, use TEC Grout Boost Advanced Pro. Although it will not offer fast cure times, this product will dramatically improve the stain resistance and permanently seal your standard grout (guaranteed for TEC Accucolor standard grouts. This product is available in a 70 oz. liquid designed to treat exactly 25 lbs of dry grout (use instead of water - but may add extra water to achieve desired consistency.)**

To view video of PSC GEN II Drain install in standard shower kit, scan or visit:

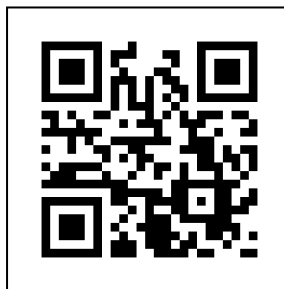

https://youtu.be/TNDFrp4Ns_M